

# ***IP RECEIVER***

***GRx 8-32***

***User's Guide***



Canadian Manufacturer of  
Geophysical Instruments Since 1976

**INSTRUMENTATION GDD INC.**

3700, boul. de la Chaudière, Québec (Québec) Canada G1X 4B7

Tel. : (418) 877-4249 Fax : (418) 877-4054

[WWW.GDDINSTRUMENTATION.COM](http://WWW.GDDINSTRUMENTATION.COM)

## Table of contents

<b>1 Introduction</b> .....	<b>3</b>
<b>2 GRx8-32 accessories</b> .....	<b>4</b>
<b>3 GRx8-32 components</b> .....	<b>6</b>
<b>4 Quick start guide</b> .....	<b>8</b>
<b>5. RS232/BLUETOOTH communication</b> .....	<b>14</b>
<b>5 Tools menu</b> .....	<b>16</b>
<b>5.1 Config option</b> .....	<b>18</b>
<b>5.1.1 Setup</b> .....	<b>18</b>
<b>5.1.2 Position</b> .....	<b>20</b>
<b>5.1.3 Windows</b> .....	<b>22</b>
<b>5.2 Special option</b> .....	<b>25</b>
<b>5.2.1 Reinit</b> .....	<b>25</b>
<b>5.2.2 Simulation</b> .....	<b>26</b>
<b>5.3 Graph option</b> .....	<b>27</b>
<b>5.3.1 Signal</b> .....	<b>27</b>
<b>5.3.1.1 Tools menu</b> .....	<b>29</b>
<b>5.3.1.1.1 Auto Correction</b> .....	<b>29</b>
<b>5.3.1.1.2 Restore</b> .....	<b>29</b>
<b>5.3.1.1.3 PAUSE/GO</b> .....	<b>30</b>
<b>5.3.2 Noise</b> .....	<b>31</b>
<b>5.3.3 Cycle</b> .....	<b>33</b>
<b>5.4 Show option</b> .....	<b>34</b>
<b>5.4.1 Show Windows</b> .....	<b>34</b>
<b>5.4.2 Show Sp</b> .....	<b>35</b>
<b>5.4.3 Decay Curve</b> .....	<b>36</b>
<b>5.5 Memory option</b> .....	<b>37</b>
<b>5.5.1 Back Mem</b> .....	<b>37</b>
<b>5.5.2 Clear Mem</b> .....	<b>38</b>
<b>5.5.3 Save File</b> .....	<b>40</b>
<b>5.6 About option</b> .....	<b>42</b>
<b>6 Data tranfer</b> .....	<b>43</b>
<b>6.1 ActiveSync installation and settings</b> .....	<b>43</b>
<b>6.2 Connect the Allegro Cx with a desktop PC</b> .....	<b>44</b>
<b>6.3 Transfer file(s) from the Allegro Cx to a desktop PC</b> .....	<b>45</b>
<b>7 Bluetooth configuration</b> .....	<b>47</b>
<b>8 GDD Rx software update</b> .....	<b>54</b>
<b>9 GRx8-32 CPU update</b> .....	<b>58</b>
<b>10 Technical help</b> .....	<b>62</b>

## 1 Introduction

The GDD IP Receiver is a new compact and low consumption unit designed for high productivity resistivity measurements. It features some high capabilities allowing working in any field conditions. It can be configured in multi-pole or multi-dipole reception.

The receiver uses a PDA computer to process acquisition data. A VGA display allows visualizing the results. The operating system is Windows CE and the software can easily be updated via internet.

### Characteristics:

- **Reception poles/dipoles:** 8 poles/dipoles, expandable to 32, for dipole-dipole, pole-dipole or pole-pole arrays.
- **Programmable windows:** The GRx8-32 offers twenty fully programmable windows for a higher flexibility in the definition of the IP decay curve.
- **User modes available:** Arithmetic, logarithmic, semi-logarithmic, Cole-Cole, IPR-12 and user define.
- **IP display:** Chargeability values, Resistivity and IP decay curves can be displayed in real time thanks to the VGA screen. Before data acquisition, the GRx8-32 can be used as a one channel graphic display for monitoring the noise level and checking the primary voltage waveform through a continuous display process.
- **Internal memory:** Can store up to 64 000 readings for 8 poles/dipoles, memory expandable up to 512 000 readings upon PDA model, each reading includes the full set of parameters characterizing the measurements. The data is stored in flash memories not requiring any lithium battery for safeguard

## 2 GRx8-32 accessories

A	1x	GRx8-32 IP receiver module
B	1x	Operation manual
C	1x	GRx8-32 IP receiver wall charger
D	10x	Red cable banana/alligator
E	2x	Black cable banana/alligator
F	1x	Allegro Cx field computer
G	1x	Allegro Cx wall charger
H	1x	Allegro Cx CE serial communication cable 9 pos. D-SUB female - 9 pos. D-SUB female
I	2x	Allegro Cx CE serial communication cable 9 pos. D-SUB female - 4 pos. Amphenol male
J	1x	Allegro Cx pen-style stylus
K	1x	Allegro Cx shoulder strap
L	1x	Allegro Cx hand strap
M	2x	Allegro Cx NIMH battery pack 3000mAh 3.6V
N	1x	Allegro Cx external NIMH 3000mAh 3.6V battery charger
O	1x	Allegro Cx utility CD
P	1x	Allegro Cx AA alkaline battery holder
Q	1x	Charger with 4 AA 2400mAh 1.2V NIMH batteries
R	1x	Allegro Cx USB power dock
S	1x	Allegro Cx USB cable for USB power dock



### 3 GRx8-32 components

The GRx8-32 components are described in this section.

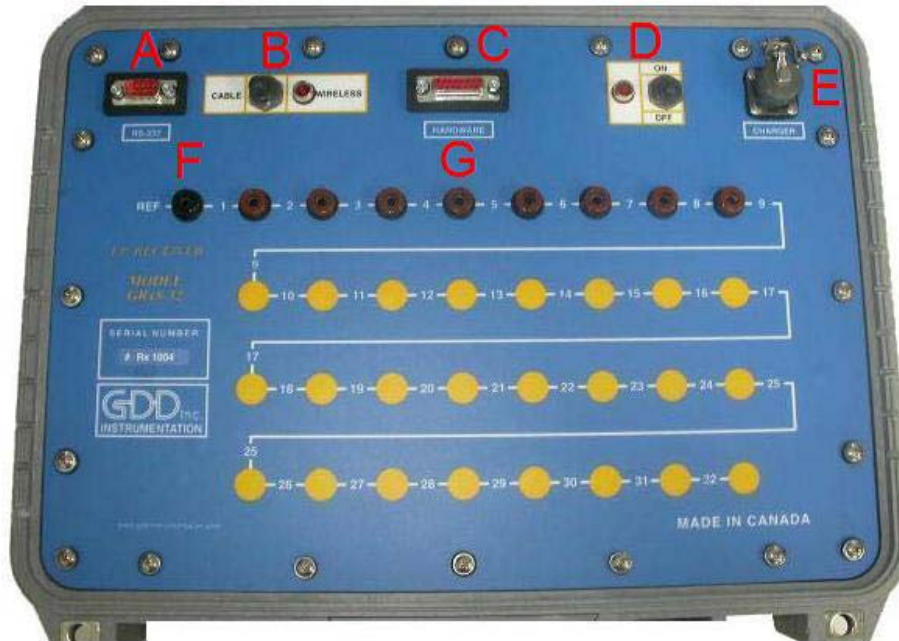

#### A - RS-232 connector - 9 pin serial communication port

This connector is used to connect the RS-232 cable between the Allegro Cx and the GRx8-32.

#### B - CABLE/WIRELESS switch

This switch is used to select CABLE (RS-232) or WIRELESS (Bluetooth) communication with the PDA. The red light indicates WIRELESS position.

#### C - HARDWARE connector - 15 pin programming port

This connector is used to update the CPU and PLD software.

**D - ON/OFF switch**

This switch is used to turn the GRx8-32 ON and OFF. The red light indicates ON position.

**E - CHARGER connector**

This connector is used to charge the 12V receiver's battery.

**F - REF terminal**

This terminal is the infinity electrode in pole configuration. In dipole configuration, this terminal is the first electrode in differential with the second electrode.

**G - NUMBERED terminals**

These terminals are referenced to the Ref terminal, infinity in pole configuration. In dipole configuration, the numbered terminals are differential terminals.

## 4 Quick start guide

1. Connect the electrodes into the terminals.
2. Turn ON the IP receiver using the ON/OFF switch on the GRx8-32 panel.
3. Select the communication mode using the CABLE/WIRELESS switch on the GRx8-32 panel.
4. Connect the RS-232 cable between the Allegro Cx (COM1) and the GRx8-32 RS-232 connector (CABLE communication only).
5. Turn ON the Allegro Cx with the On/Off key.



6. Double click on the “GDD Rx” icon.



7. Select the communication mode: *RS-232 (CABLE)* or *BLUETOOTH (WIRELESS)*.

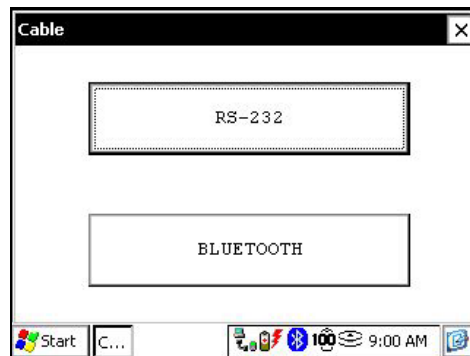

8. The following screen appears.

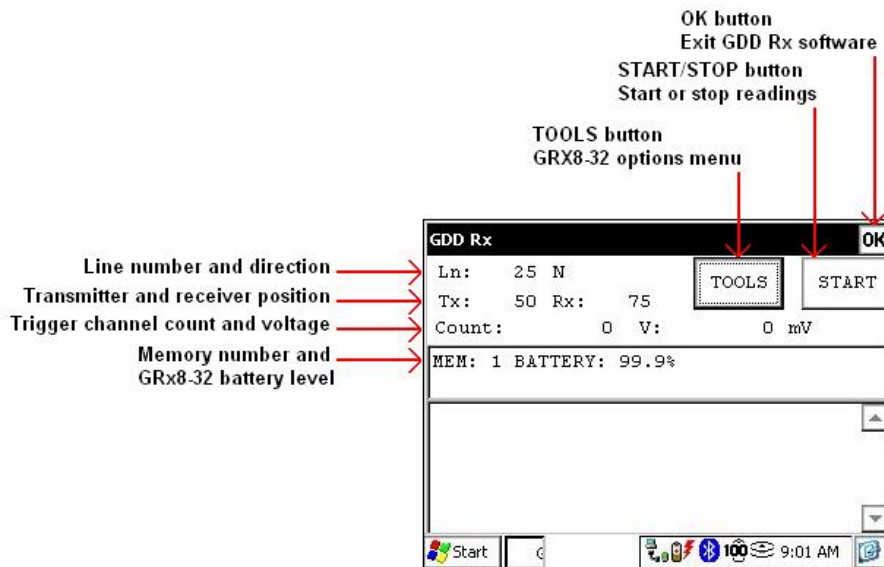

9. Click on the *Start* button to begin the acquisition procedure.

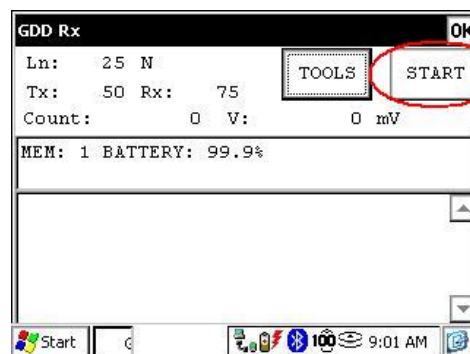

10. The following screen appears. Click on the *Ok* button to continue.

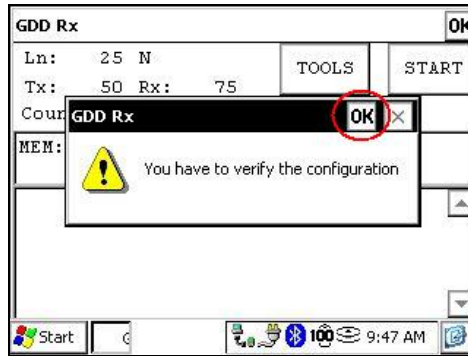

11. Enter the line informations, the first electrode position and the increment. Click on the *Ok* button to continue.

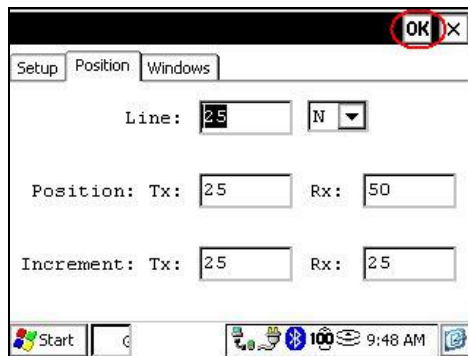

12. Enter or move (backward or forward) the transmitter and receiver position. Click on the *Ok* button to continue.

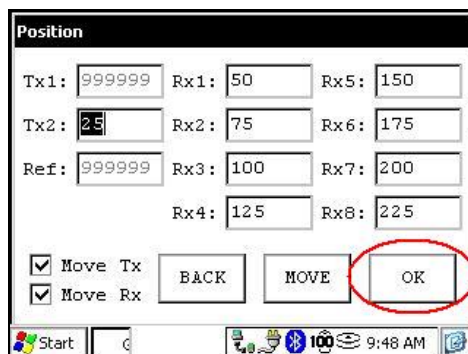

13. If the contacts are correct, click on the *Next* button to continue.

\*Note: If all stations show an INFINITE contact, the reference electrode might be disconnected.

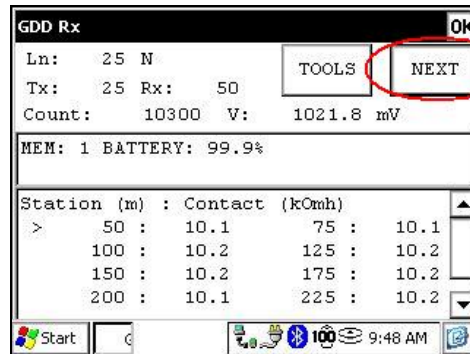

14. Enter the transmitter current and click on the *Confirm* button to start the readings or use the tab and enter key.

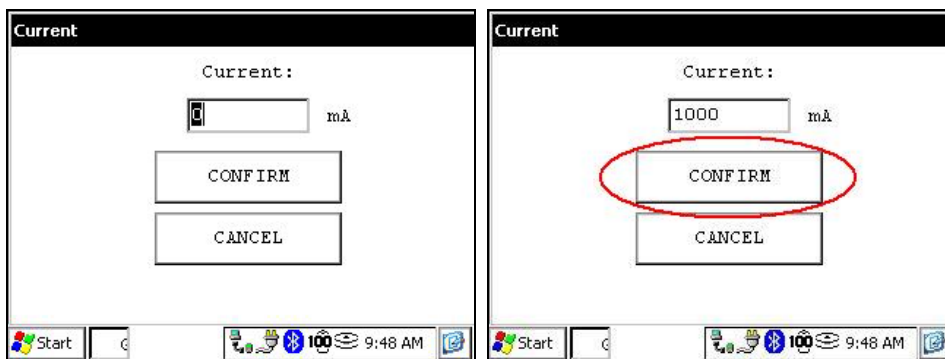

15. The following screens appears.

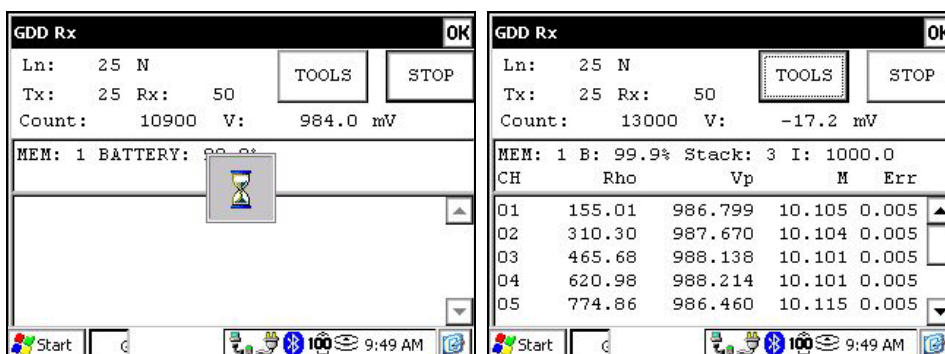

16. Click on the *Stop* button or wait after the end of the acquisition (50 stacks) to stop the readings and save the data.

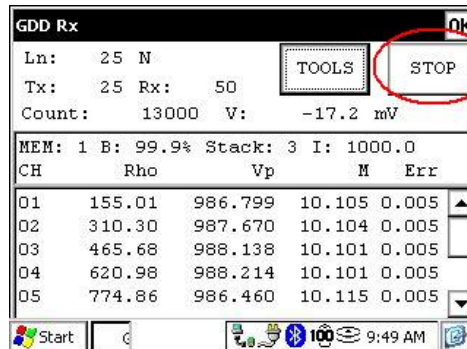

17. Click on the *Yes* button to confirm the operation.

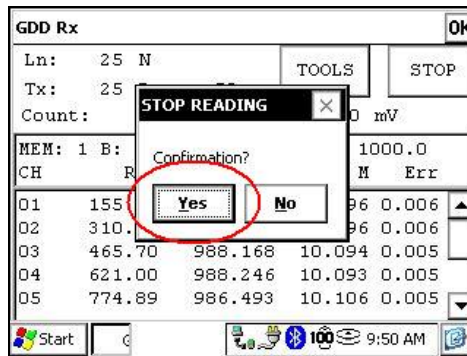

18. Click on the *Yes* button to save readings into the memory.

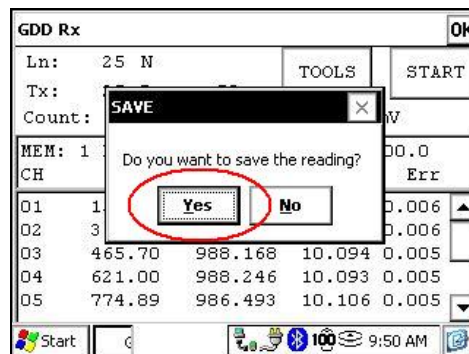

19. Check the *Redo positions* option to change the transmitter or receiver position.

Change the current value if it has changed and click on the *Confirm* button to save the current value.

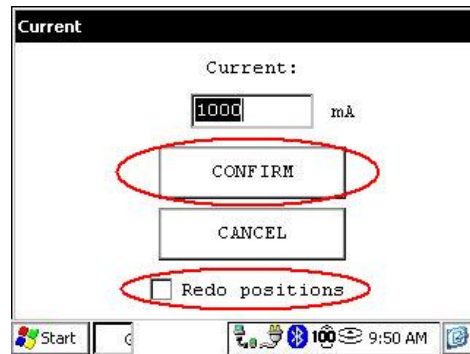

- 19.1. If the *Redo positions* option is enable, enter the transmitter and receiver position and click on the *Ok* button.

\*Each position can be change individually.

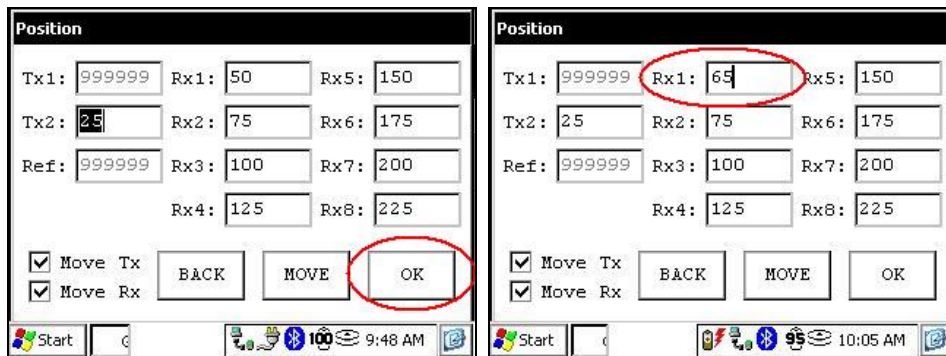

20. Repeat steps 9 through 19 to take another set of readings.

## 5. RS232/BLUETOOTH communication

1. Select the “RS-232” communication mode to use the GRx8-32 with a serial communication cable.

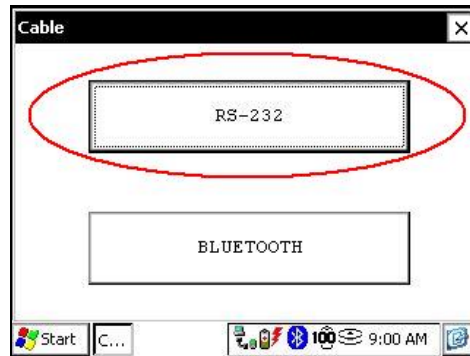

2. Select the “BLUETOOTH” communication mode to use the GRx8-32 with a wireless connection.

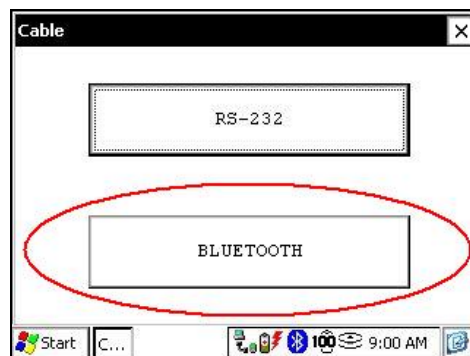

### 2.1 The Bluetooth Device Search begin.



2.2 Select the Bluetooth device you want to use (the device name can be the GRx8-32 serial number or Brainboxes Adapter).



2.3 Select the "Serial 01" Service Name and click on the "Select" button.



3. The following screen appears.

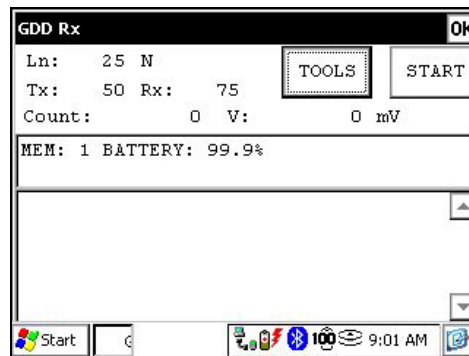

## 5 Tools menu

Click on the *Tools* button to select one of the following options:

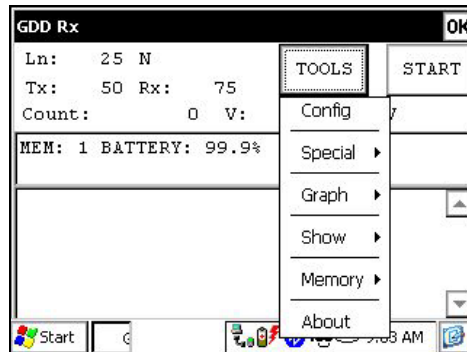

### **Config**

Use the Config option to change:

- Electrode array
- Active channel
- Trigger channel
- Line number and position
- Transmitter and receiver position
- Signal timing
- Mode

### **Special**

Use the Special option to:

- Reinit the GRx8-32
- Test the GRx8-32 with the internal simulator

### **Graph**

Use the Graph option to display:

- Signal graph
- Noise monitor graph
- Cycle synchronization graph

## **Show**

Use the Show option to display:

- Windows chargeability
- SP (self potential)
- Decay curve

## **Memory**

Use the Memory option to:

- Recall the previous memory
- Clear the memory
- Save the data in a file

## **About**

Use the About option to display:

- GDD Rx software version

## 5.1 Config option

### 5.1.1 Setup

The *Setup* option is used to set the the electrode array, the active channel(s) and the trigger channel.

1. Select Tools | Config | Setup

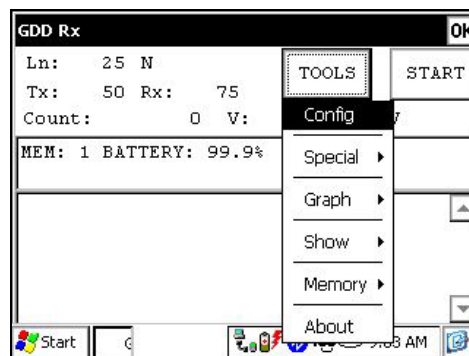

2. The following screen appears.

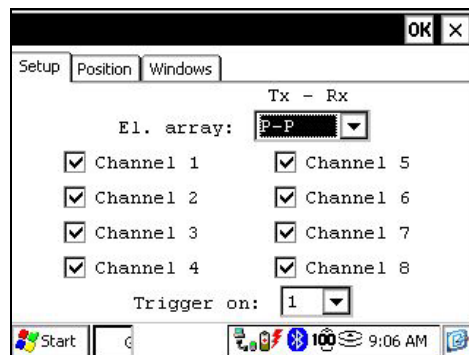

3. Select the electrode array configuration:
  - Dipole-Dipole
  - Pole-Pole
  - Pole-Dipole

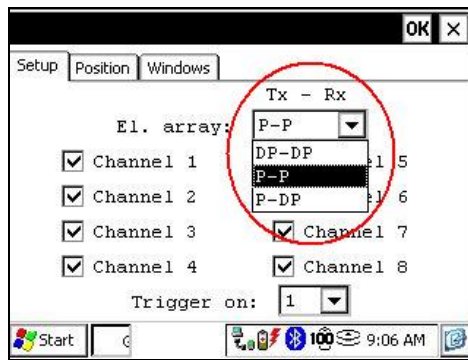

4. Check the active channel(s).

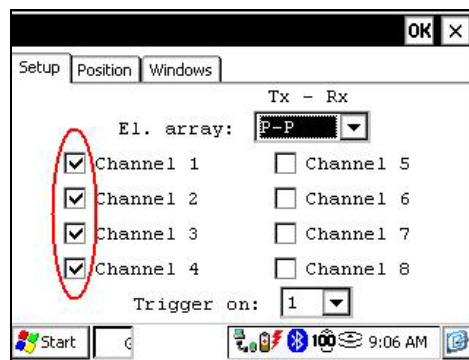

5. Select the trigger channel, this channel is used for the synchronization process.

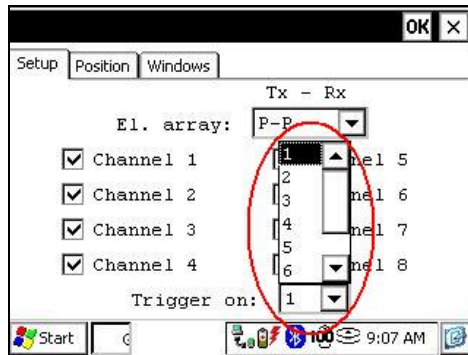

## 5.1.2 Position

The *Position* option is used to set the line number and direction, the transmitter and receiver position and the transmitter and receiver increment.

1. Select Tools | Config | Position

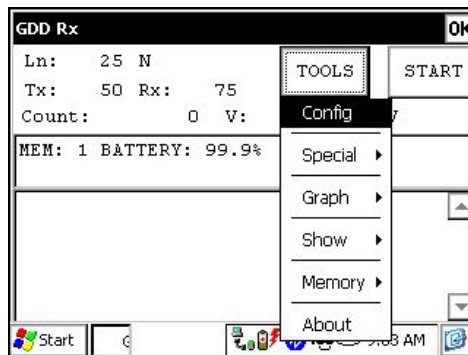

2. The following screen appears.

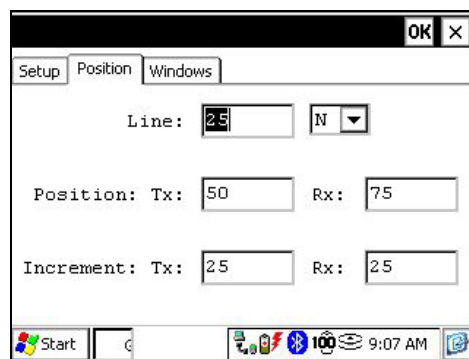

3. Enter line number and select line direction.

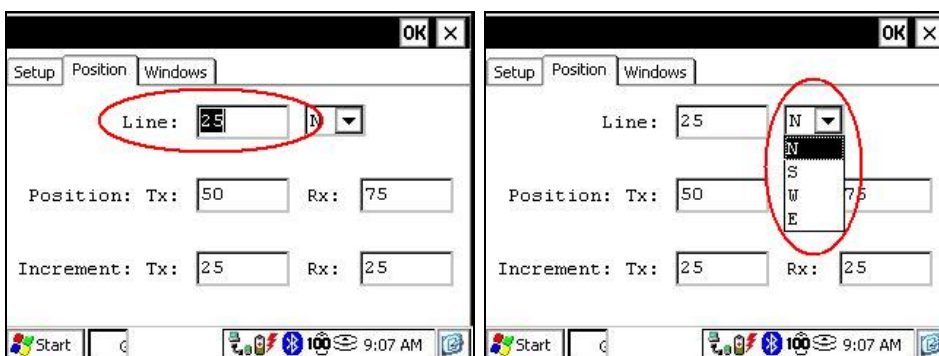

4. Enter the transmitter and receiver first electrode position.

The screenshot shows a software window with three tabs: 'Setup', 'Position', and 'Windows'. The 'Position' tab is selected. The 'Line' field contains '25' and a dropdown menu shows 'N'. The 'Position' section has 'Tx' set to '50' and 'Rx' set to '75', which are circled in red. Below, the 'Increment' section has 'Tx' set to '25' and 'Rx' set to '25'. The Windows taskbar at the bottom shows the Start button, a drive icon 'C:', and system icons for network, volume, and battery, with the time '9:07 AM'.

5. Enter the transmitter and receiver electrodes increment (displacement between readings).

This screenshot is identical to the previous one, showing the same software window with the 'Position' tab active. In this view, the 'Increment' section, with 'Tx' set to '25' and 'Rx' set to '25', is circled in red. The 'Position' fields ('Tx: 50', 'Rx: 75') are no longer circled. The taskbar and system icons remain the same.

### 5.1.3 Windows

The *Windows* option is used to set the signal timing and the mode.

1. Select Tools | Config | Windows

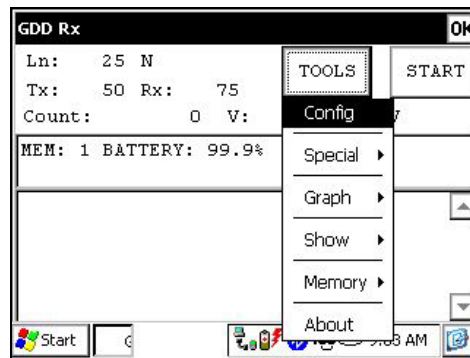

2. The following screen appears.

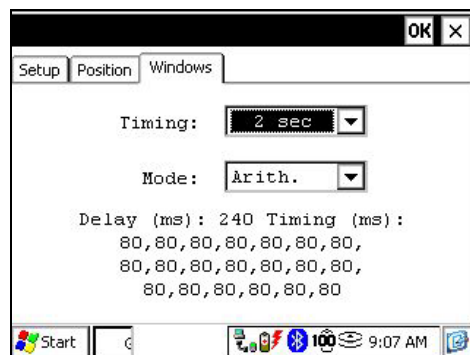

3. Select the signal timing.

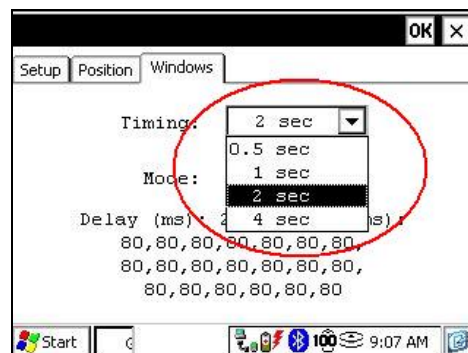

4. Select the mode (windows time definition).

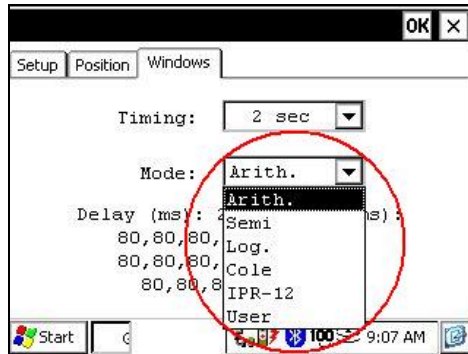

- Arithmetic

Windows: 20  
 Delay (ms): 240  
 Timing (ms): 2000  
 80, 80, 80, 80, 80, 80, 80, 80, 80, 80,  
 80, 80, 80, 80, 80, 80, 80, 80, 80, 80

- Semi logarithmic

Windows: 20  
 Delay (ms): 40  
 Timing (ms): 2000  
 40, 40, 40, 40, 40, 40, 80, 80, 80, 80,  
 80, 80, 80, 160, 160, 160, 160, 160, 160, 160

- Logarithmic

Windows: 4  
 Delay (ms): 160  
 Timing (ms): 2000  
 120, 220, 420, 820

- Cole

Windows: 20  
 Delay (ms): 20  
 Timing (ms): 2000  
 20, 30, 30, 30, 40, 40, 50, 60, 70, 80,  
 90, 100, 110, 120, 130, 140, 150, 160, 180, 200

- IPR-12

Windows: 11  
Delay (ms): 50  
Timing (ms): 2000  
20, 40, 40, 80, 80, 140, 140, 230, 230, 360, 360

- User defined

Windows: between 1 and 20  
Delay (ms): user defined  
Timing (ms): user defined

If the *User* mode is selected, you have to enter the delay and the window(s) width.

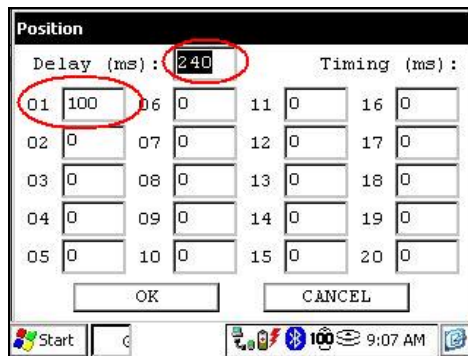

## 5.2 Special option

### 5.2.1 Reinit

The *Reinit* option is used to reset the GRx8-32 configurations and the communication with the Allegro Cx.

1. Select Tools | Special | Reinit

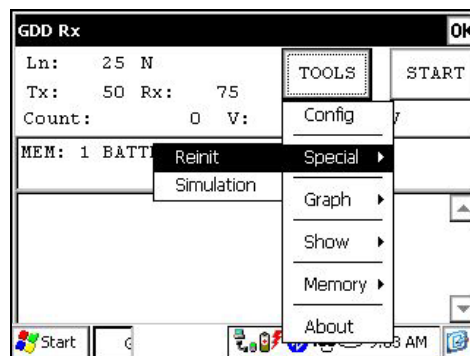

2. Click on the Yes button to reinit the GRx8-32.

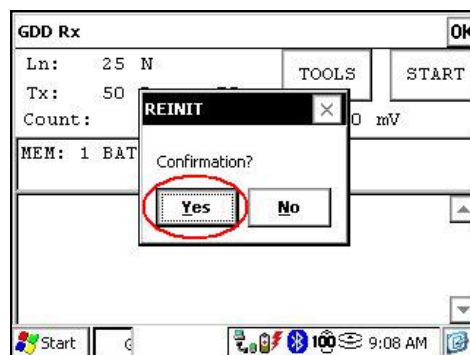

## 5.2.2 Simulation

\*\*\*\*For the next version of GRx8-32 (receiver box)\*\*\*\*

## 5.3 Graph option

### 5.3.1 Signal

The *Signal* option is used to display the signal graph of a selected channel.

1. Select Tools | Graph | Signal

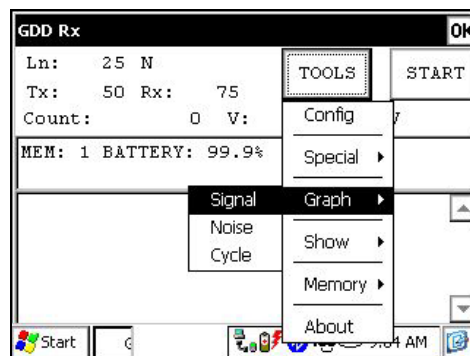

2. The following screen appears.

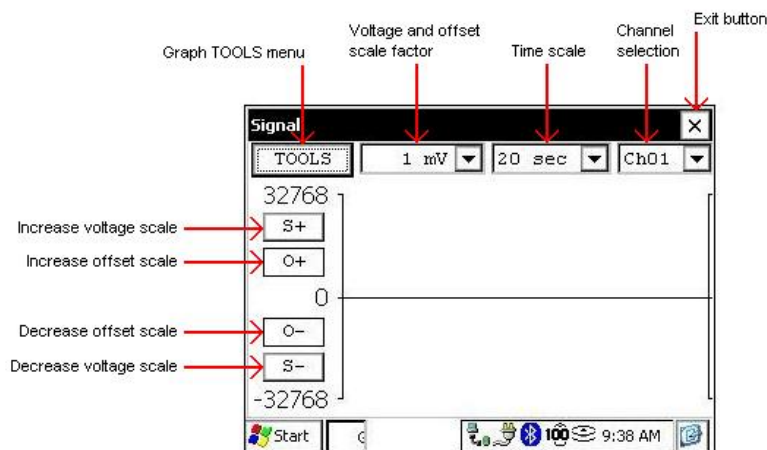

3. Select the voltage and offset scale factor.

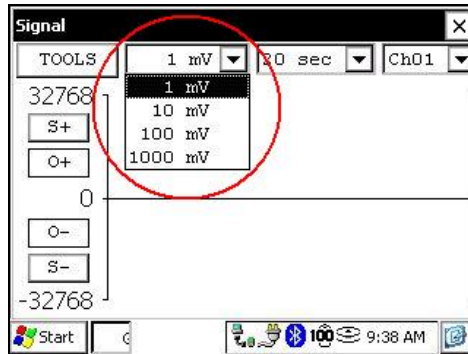

4. Select the time scale.

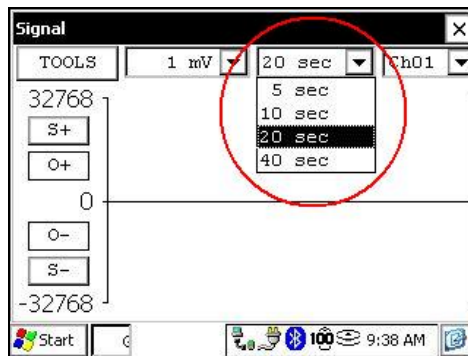

5. Select the display channel

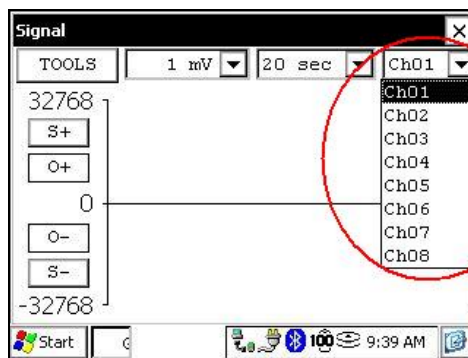

### 5.3.1.1 Tools menu

#### 5.3.1.1.1 Auto Correction

The *Auto Correction* option is used to optimized the graph scale and to correct the offset of the signal. This option should be used after one signal period (8 sec for a 2 sec time base).

1. Select Tools | Auto Correction

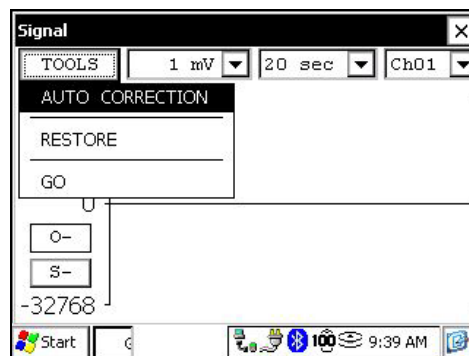

#### 5.3.1.1.2 Restore

The *Restore* option is used to reset the default setting.

1. Select Tools | Auto Correction

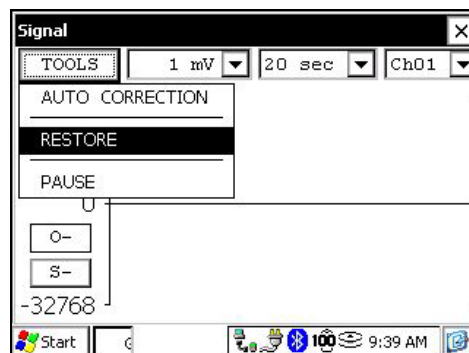

### 5.3.1.1.3 PAUSE/GO

The *Pause/Go* option is used to pause or play the signal.

1. Select Tools | Pause or Tools | Go

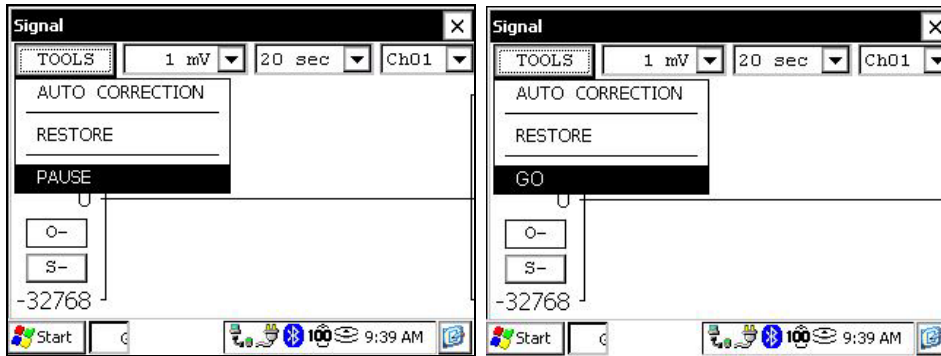

### 5.3.2 Noise

The *Noise* option is used to display the noise graph of all channels. This option can be useful for troubleshooting if you have noise problem.

\*This option should be use before the transmitter is sending current. If the transmitter is sending current the Vp signal will be displayed for each active channel.

1. Select Tools | Graph | Noise

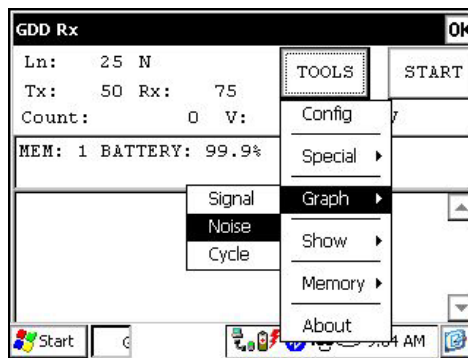

2. The following screen appears.

Transmitter is **not** sending current

Noise monitoring

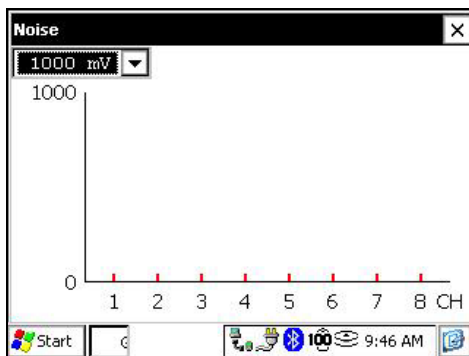

Transmitter is sending current

VP monitoring

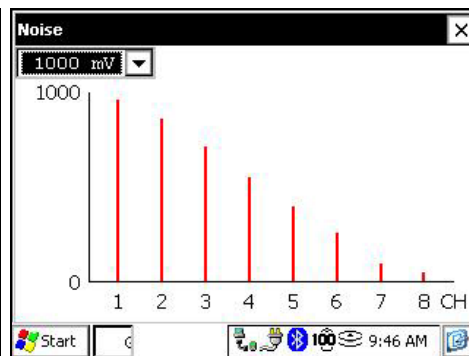

3. Select the voltage scale.

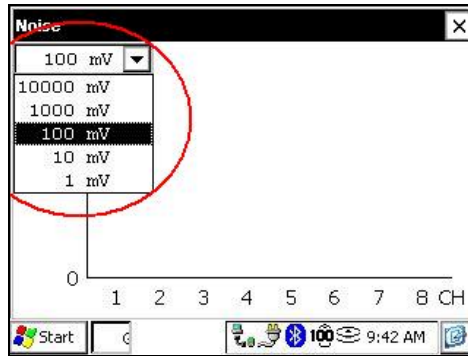

### 5.3.3 Cycle

The *Cycle* option is used to show the channel synchronization. This option can be useful for troubleshooting if you have connection problem.

1. Select Tools | Graph | Cycle

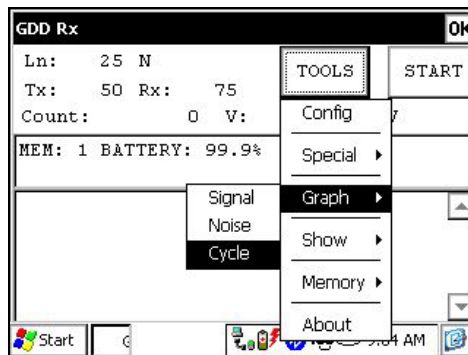

2. The following screen appears.

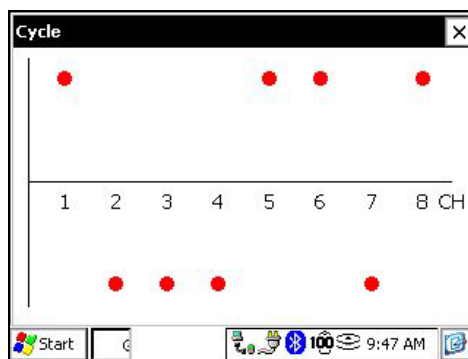

- Red dots indicate that the GRx8-32 is not synchronized.
- Green dots indicate that the GRx8-32 is synchronized.
- If the GRx8-32 is synchronized and the green dots not moving at the same direction, check the electrodes position on the GRx8-32 front panel.

## 5.4 Show option

### 5.4.1 Show Windows

The *Show Windows* option is used to display the windows chargeability of each channel.

1. Select Tools | Show | Show Windows

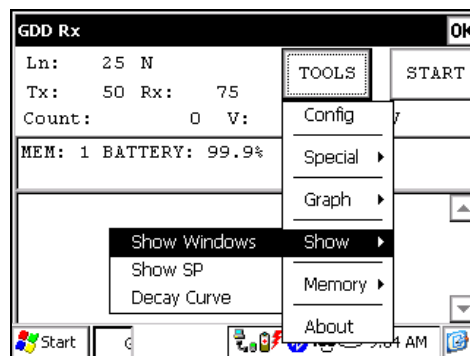

2. The following screen appears.

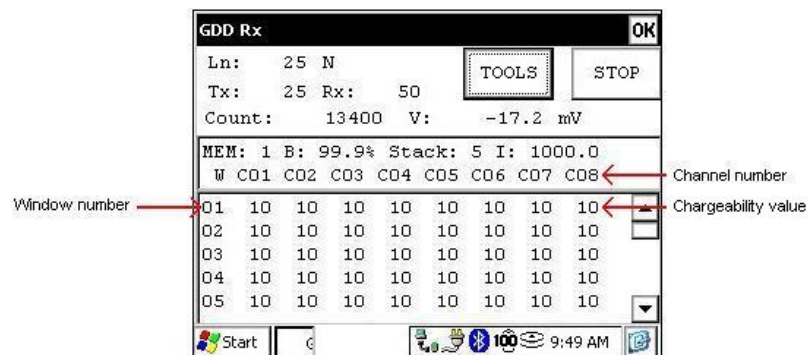

## 5.4.2 Show Sp

The *Show Sp* option is used to display the self potential (SP) in mV of each channel.

1. Select Tools | Show | Show SP

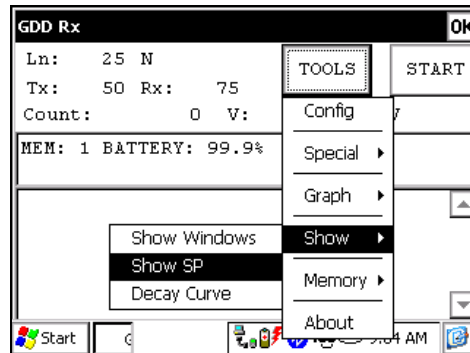

2. The following screen appears.

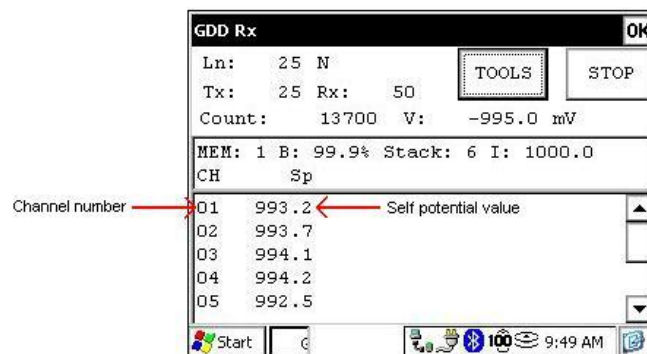

### 5.4.3 Decay Curve

The *Decay Curve* option is used to display the decay graph of a selected channel.

1. Select Tools | Show | Decay Curve

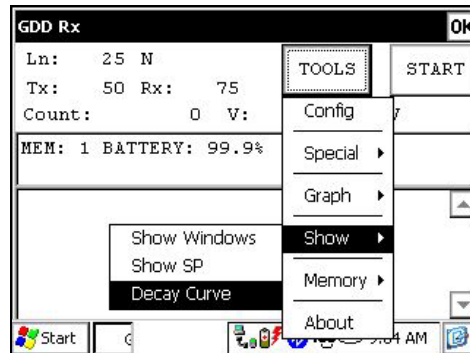

2. The following screen appears.

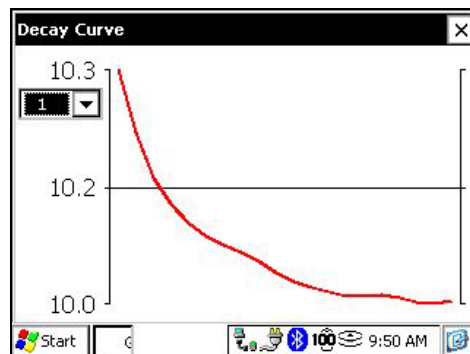

3. Select the display channel.

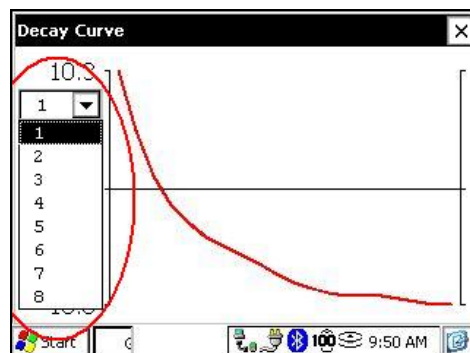

## 5.5 Memory option

### 5.5.1 Back Mem

The *Back Mem* option is used to clear the last readings into the memory.

1. Select Tools | Memory | Back Mem

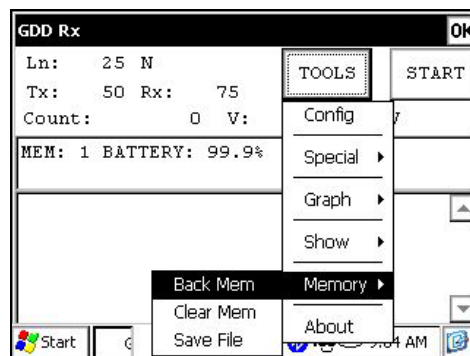

2. Click on the Yes button to clear the last readings.

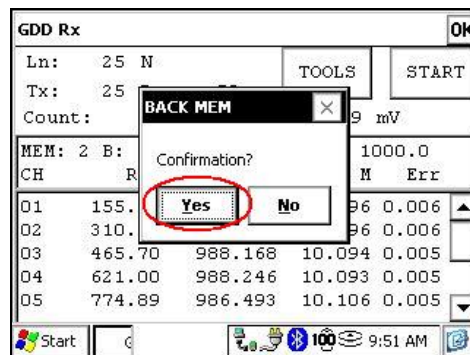

## 5.5.2 Clear Mem

The *Clear Mem* option is used to clear all the readings into the memory.

1. Select Tools | Memory | Clear Mem

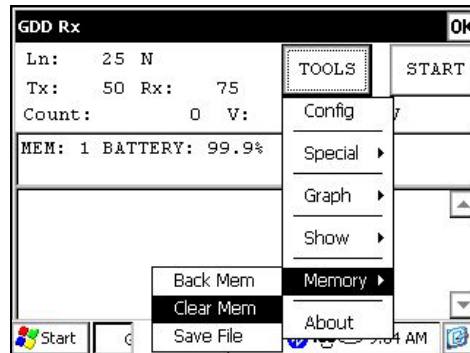

2. Click on the Yes button to confirm the operation.

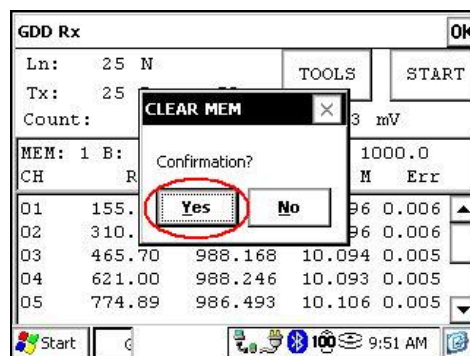

3. Enter 9999 in the text box.

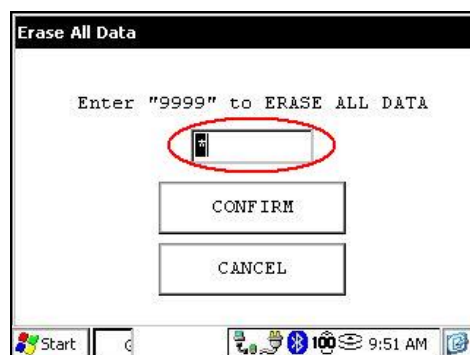

- Click on the *Confirm* button to clear all the readings into the memory.

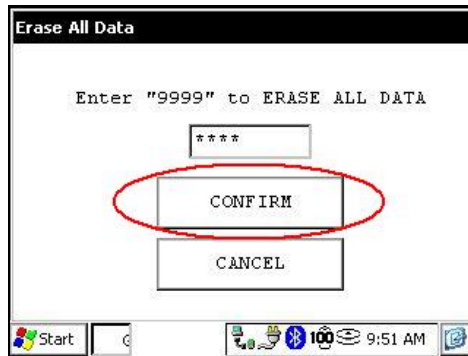

- A message will follow to confirm your operation.

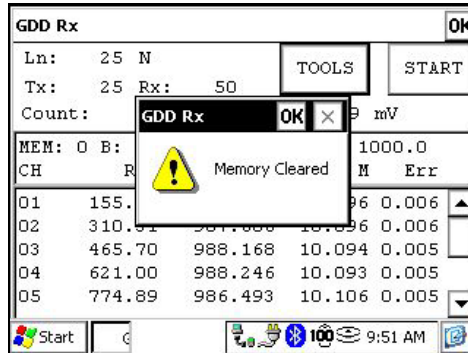

### 5.5.3 Save File

The *Save File* option is used to save the readings into a file.

1. Select Tools | Memory | Save File

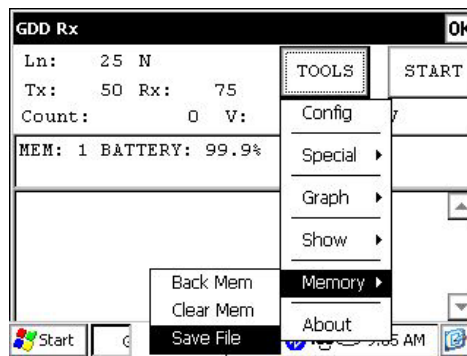

2. Enter the file name.

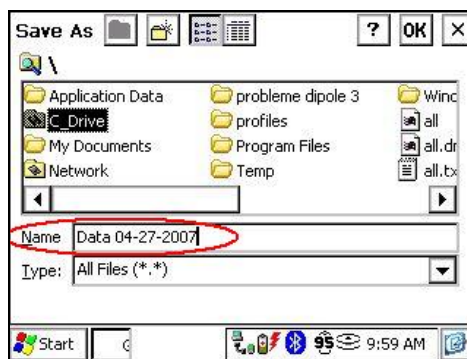

3. Double click on the C\_Drive folder.

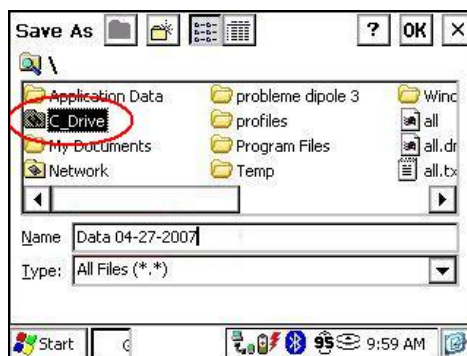

4. Click on the *OK* button.

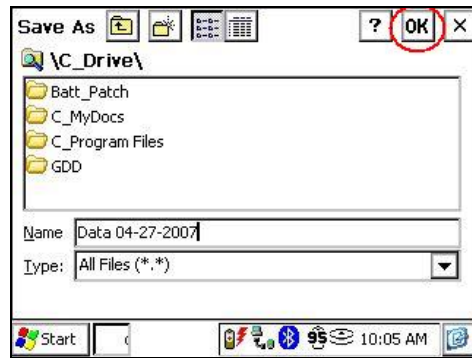

## 5.6 About option

The *About* option is used to display the software version number.

1. Select Tools | About

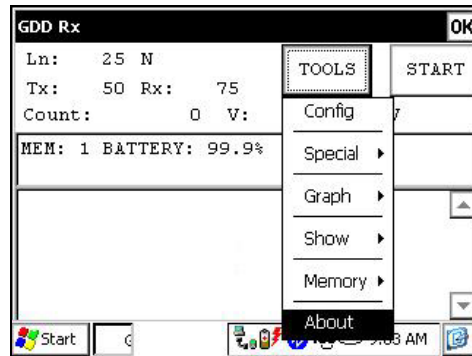

2. The following screen appears.

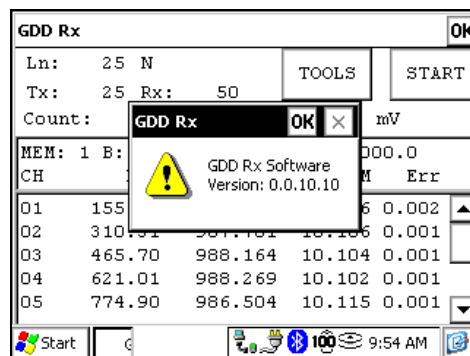

## 6 Data transfer

### 6.1 ActiveSync installation and settings

1. To establish communication between the Allegro and a desktop PC, you need to install the ActiveSync software, which is included on the CD supplied by GDD.
2. Once ActiveSync is installed, a gray icon will appear in the bottom right corner of your desktop PC screen.



3. Right click on the *ActiveSync* icon to open the following menu and select *Connection Settings...*

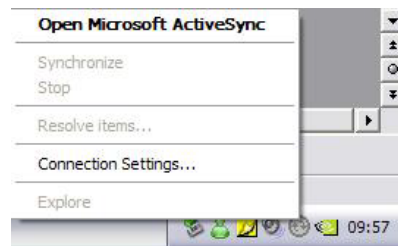

4. Check *Allow USB connection with this desktop computer.*



## 6.2 Connect the Allegro Cx with a desktop PC

1. Turn ON the PDA



2. Insert the Allegro Cx in the USB power dock



3. The desktop *ActiveSync* icon is now green.



4. A small *PCLink* icon appears on the Allegro Cx taskbar.

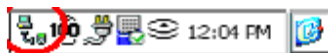

### 6.3 Transfer file(s) from the Allegro Cx to a desktop PC

1. Double click on the *My Computer* icon on your desktop PC.



2. Double click on the *Mobile Device* icon.

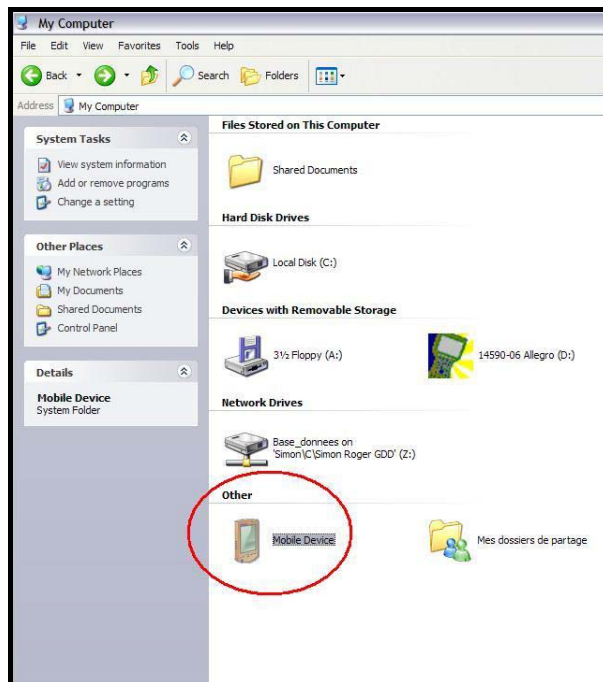

3. Double click on the *My Handheld PC* icon.

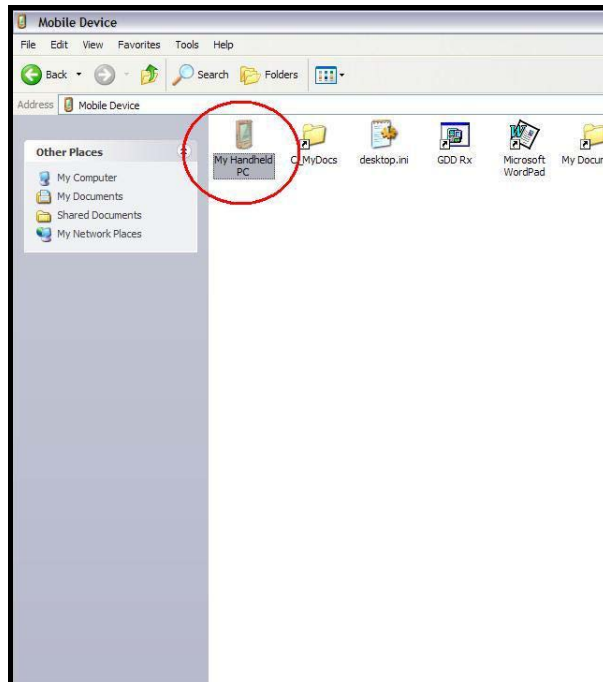

4. Use the drag and drop or cut, copy paste functions to move file(s) on your desktop PC.

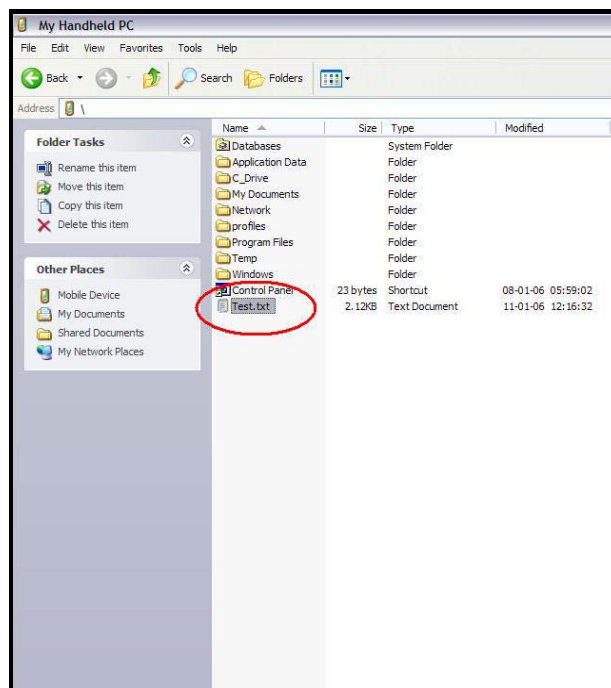

## 7 Bluetooth configuration

1. Turn On the GRx8-32 receiver.



2. Select the *Wireless* option with the *Cable / Wireless* switch.



3. Insert the *Bluetooth reset* key into the *Hardware* connector, wait 10 seconds **AND REMOVED IT**.



4. On the PDA, double click on the *My Computer* icon.



5. Double click on the *C\_Drive* folder.



6. Double click on the *GDD* folder.

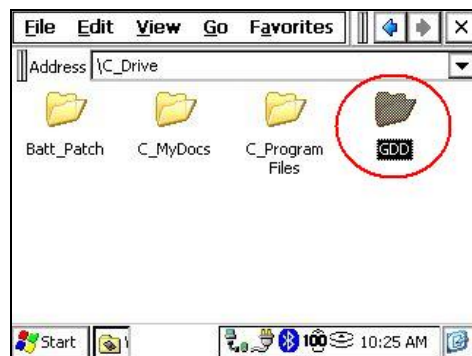

7. Double click on the *BL-830 Config* icon.

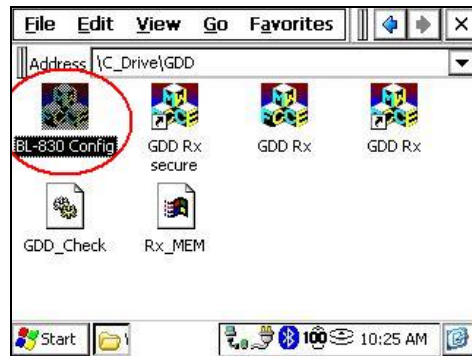

8. Click on the Yes button to confirm the operation.

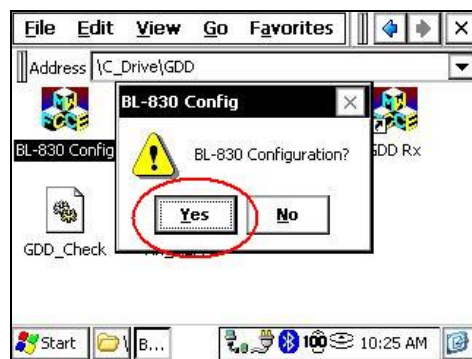

9. On the taskbar, click on the *BL-830 Config* icon.



10. Click on the *Bluetooth* button to begin the Bluetooth Device Search.

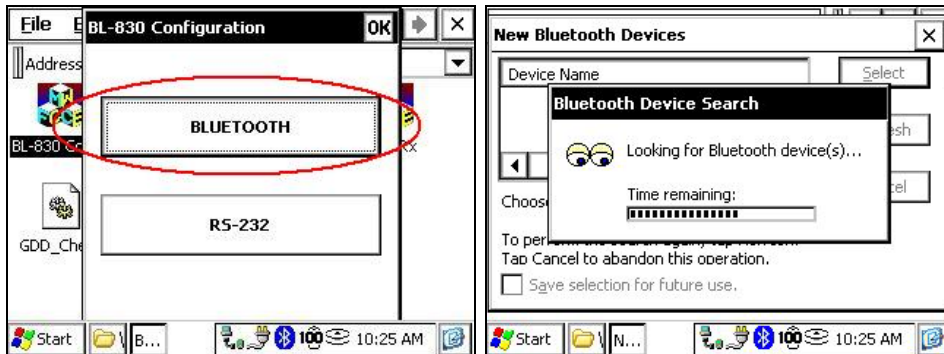

11. Select the Bluetooth device you want to config (the device name can be the GRx8-32 serial number or Brainboxes Adapter).

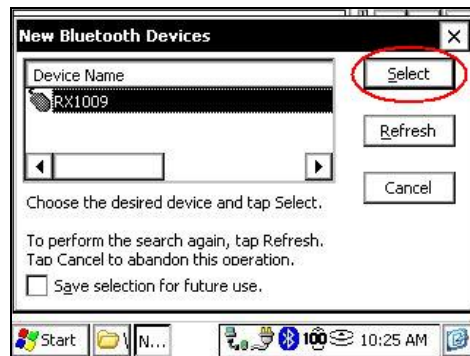

12. The following screen appears.



13. Enter the Bluetooth Passkey (the Passkey is 1234) and click on the *Reply* button.



14. The following screen appears.



15. Click on the Yes button to confirm the operation.



16. Select the *Remote Config* option and click on the *Select* button.



17. On the taskbar, click on the *BL-830 Config* icon.

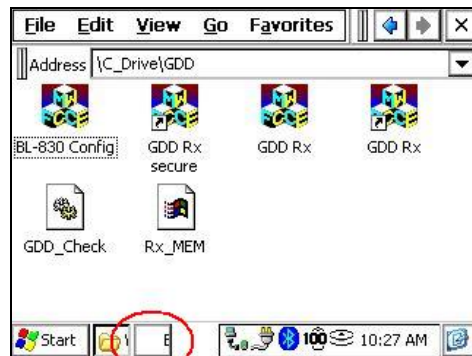

18. Select your module (Rx for Grx8-32 receiver) and click on the *Config* button.

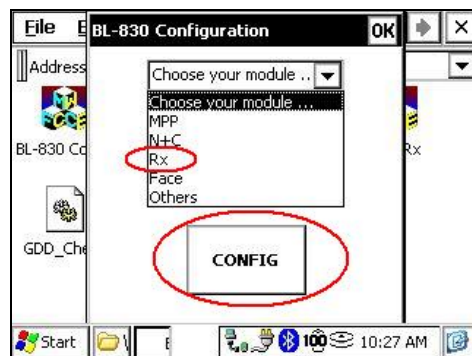

19. Enter your GRx8-32 serial number and click on the *Config* button.

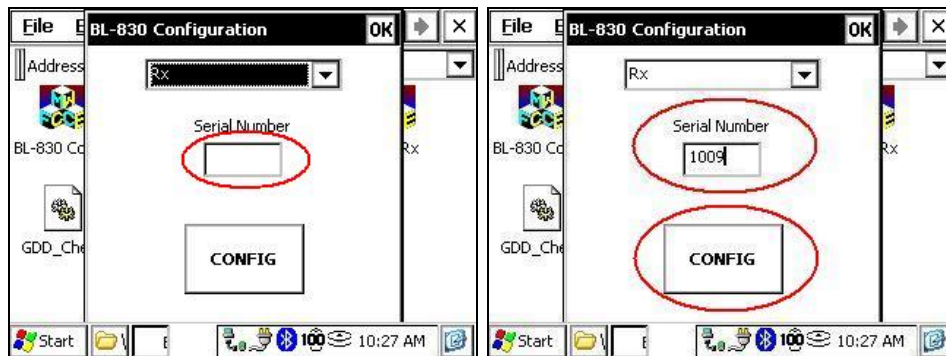

20. When the configuration is completed, the following screen appears. Click on the *Ok* button to close the window.

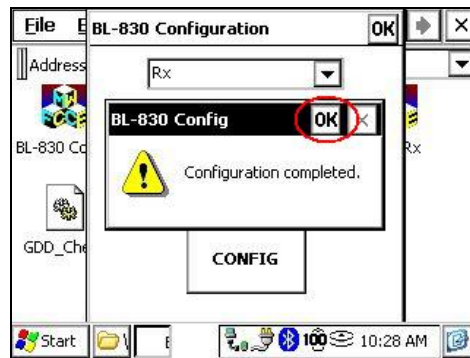

21. Click on the *X* button to close the window.



## 8 GDD Rx software update

1. Place the Allegro into the USB/Power Dock. The Allegro automatically turns on.



2. Double click on the *My Computer* icon on the desktop of your PC.



3. Double click on the Mobile Device icon.

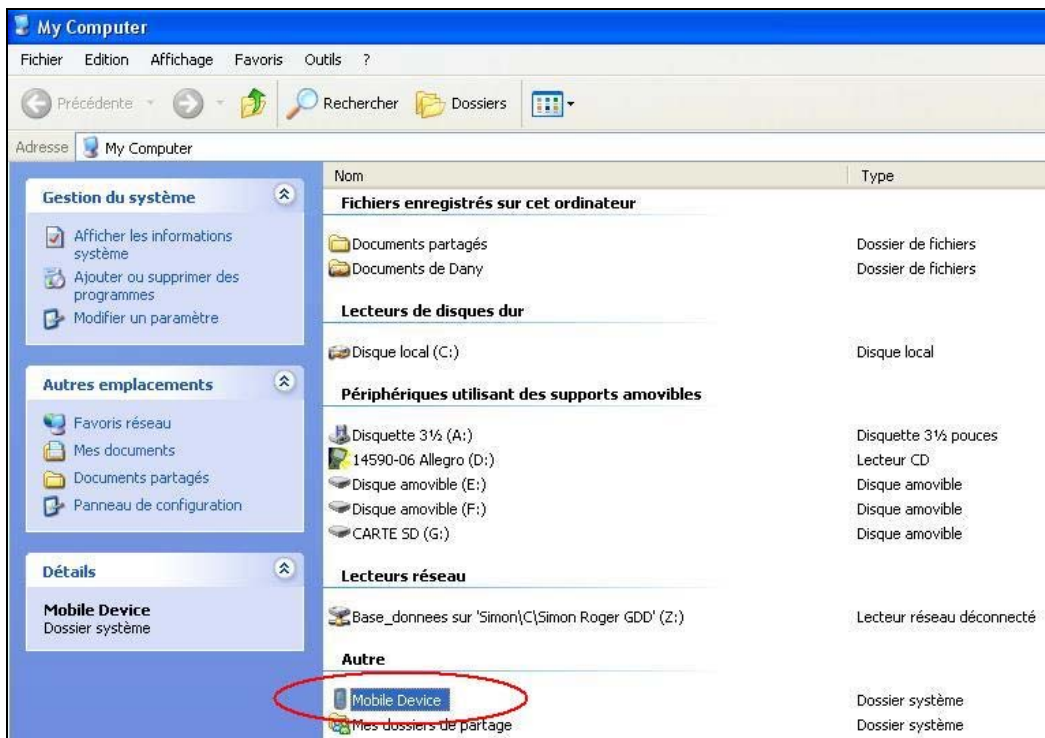

4. Double click on the MyHandheld PC icon.

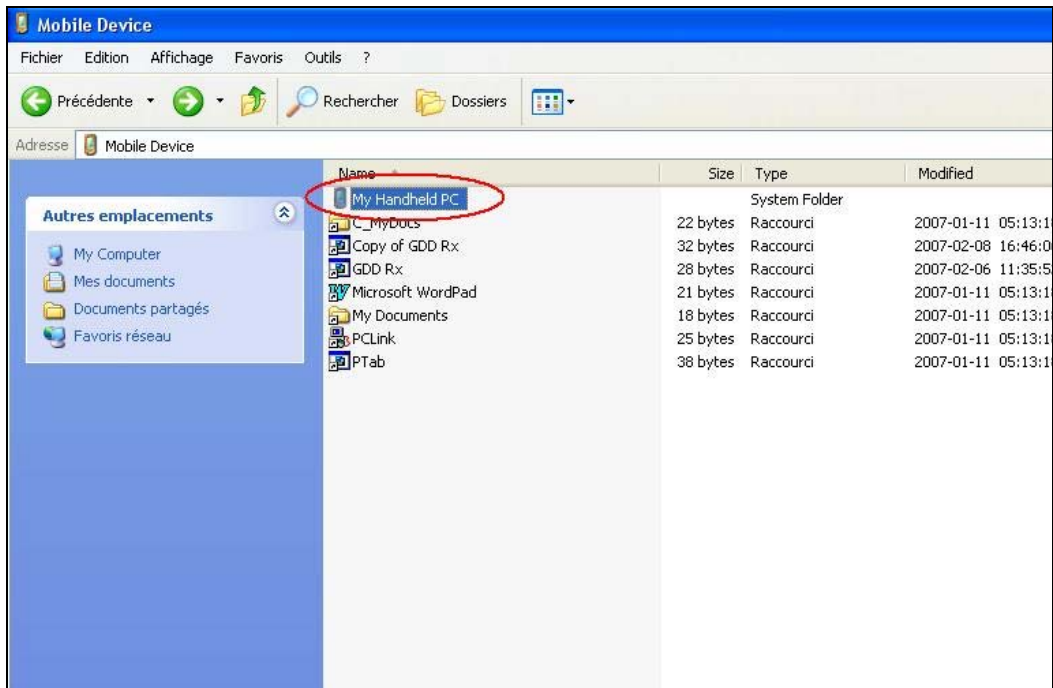

5. Double click on the C\_Drive icon.

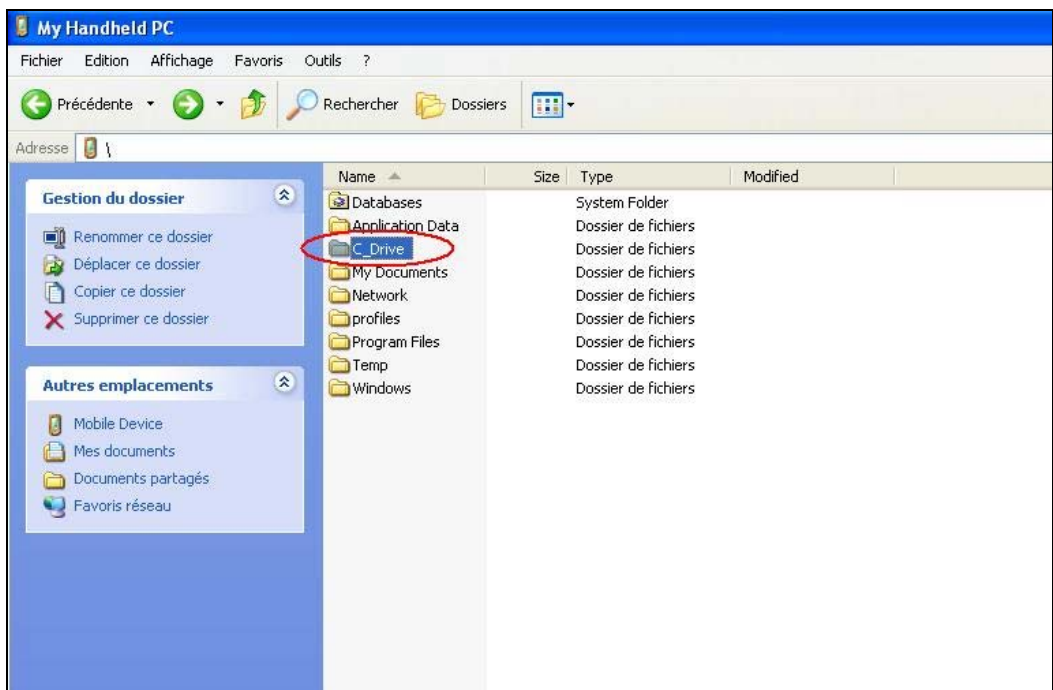

6. Double click on the GDD icon.

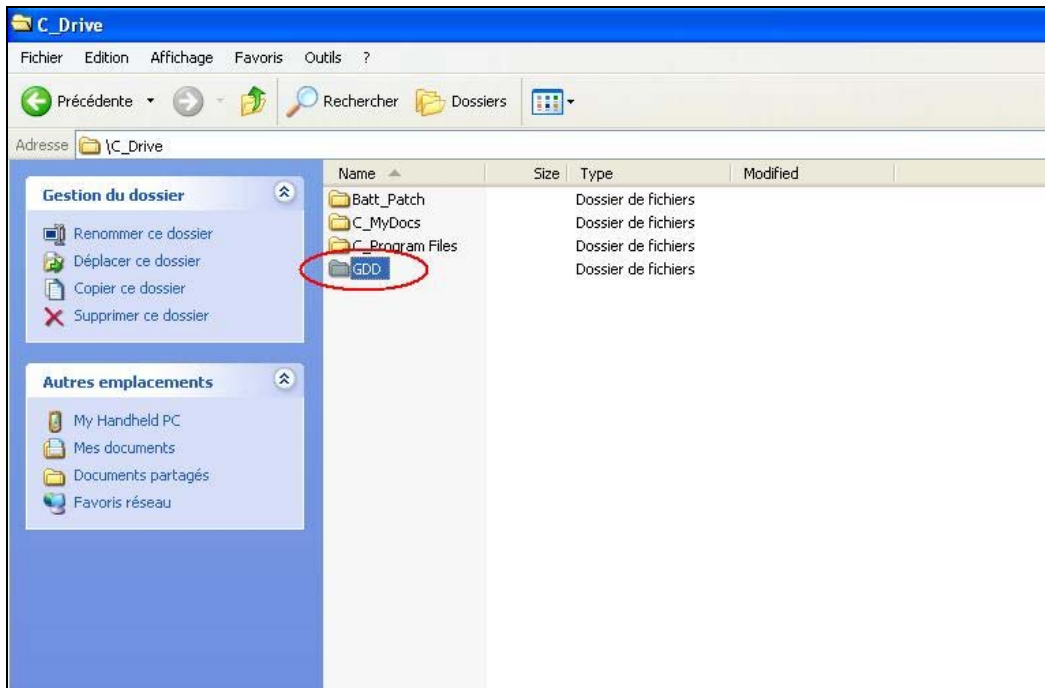

7. Rename the old version of the software to keep a backup on your Allegro Cx. Right click on the GDD Rx.exe icon and click on the Rename option.

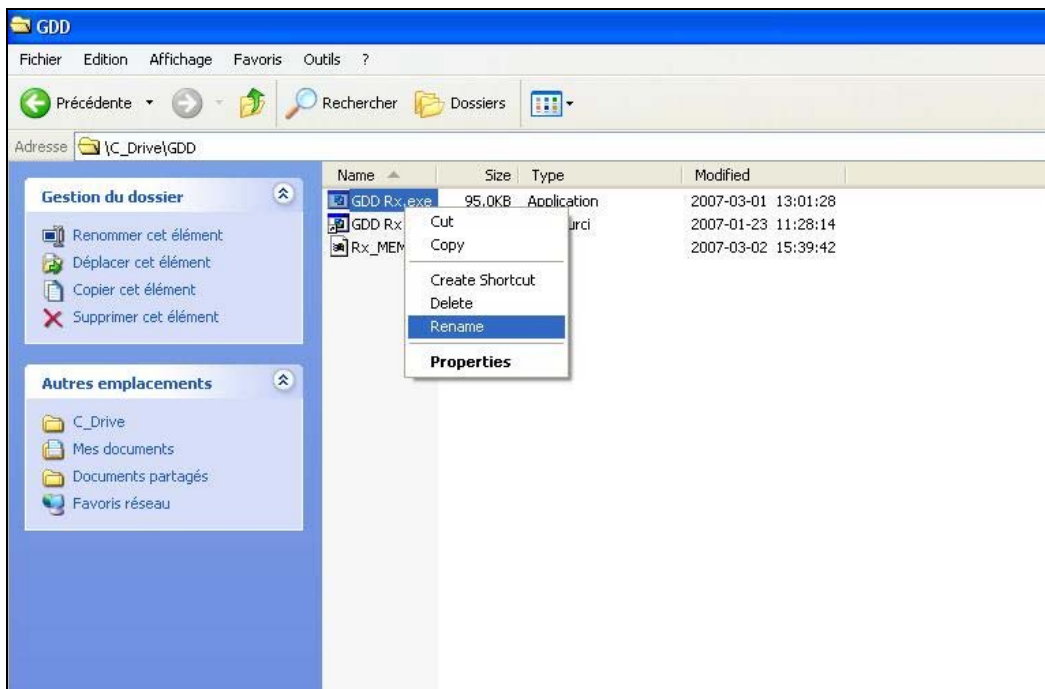

Rename the software (example: GDD\_Rx\_Old Version.exe)

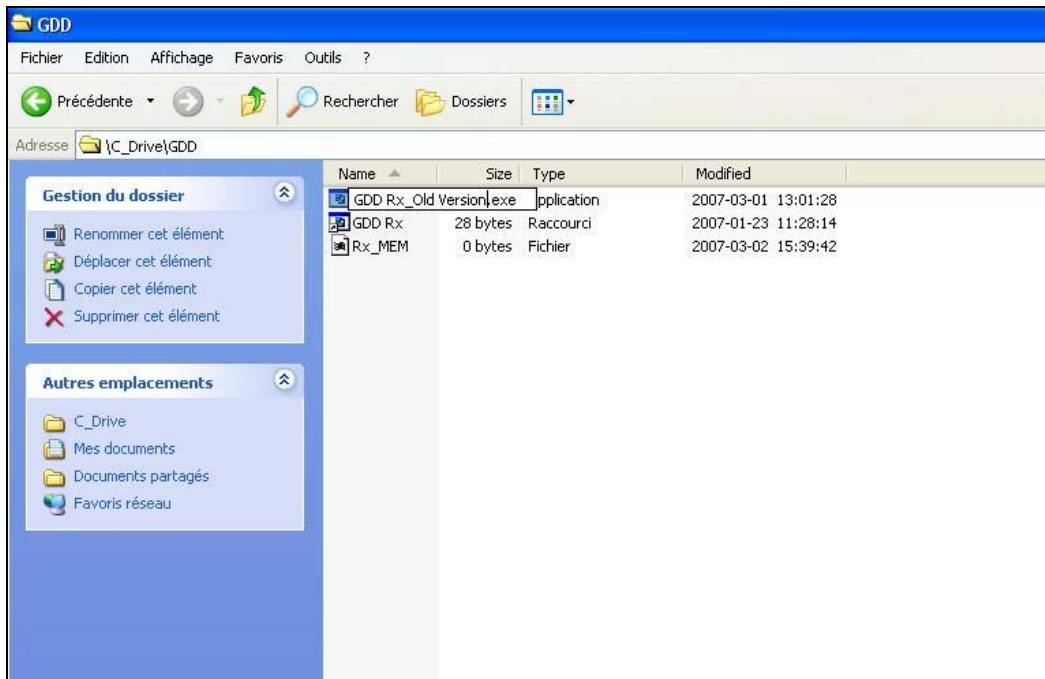

8. Use the drag and drop or the copy and paste functions to update the GDD Rx.exe software.

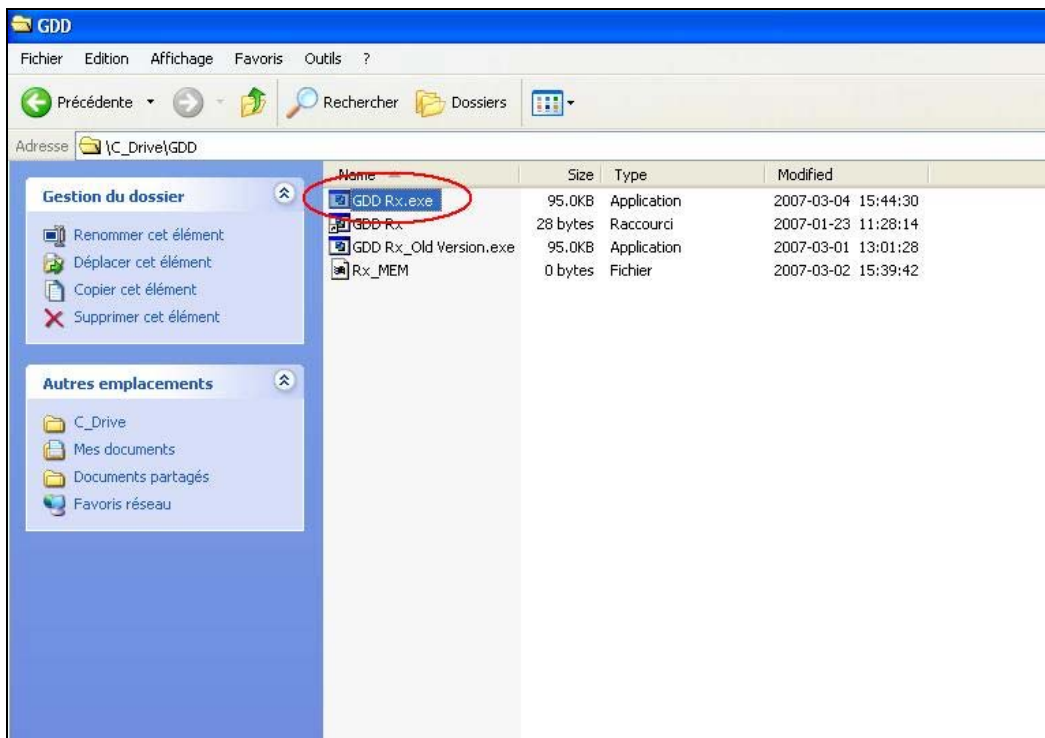

## 9 GRx8-32 CPU update

1. Insert the *Bootloader* key into the *RS-232* connector.

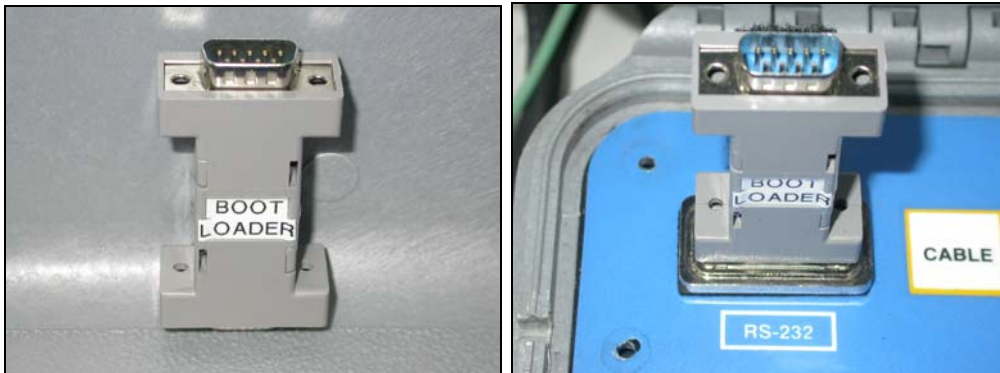

2. Connect one end of the serial communication cable to the *Bootloader* key.



3. Connect the other end of the serial communication cable to the COM 1 or 2 port on your desktop PC.



4. Select the *Cable* option with the *Cable / Wireless* switch.



5. Turn On the GRx8-32 receiver.



6. Double click on the My Computer icon on the desktop of your PC.



7. Enter the serial port number and click on the *Open Port* button.

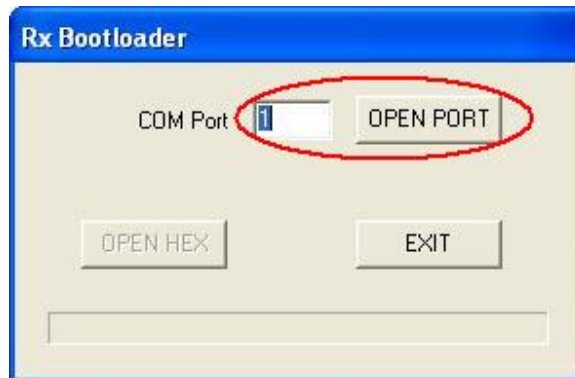

8. The following screen appears.

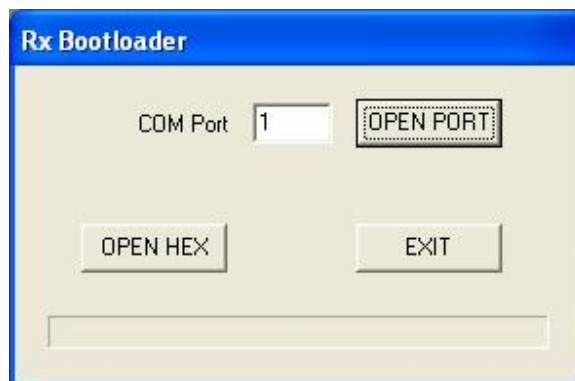

9. Click on the *Open Hex* button.



10. Select the new version of the CPU software (.hex file) and click on the *Open* button.

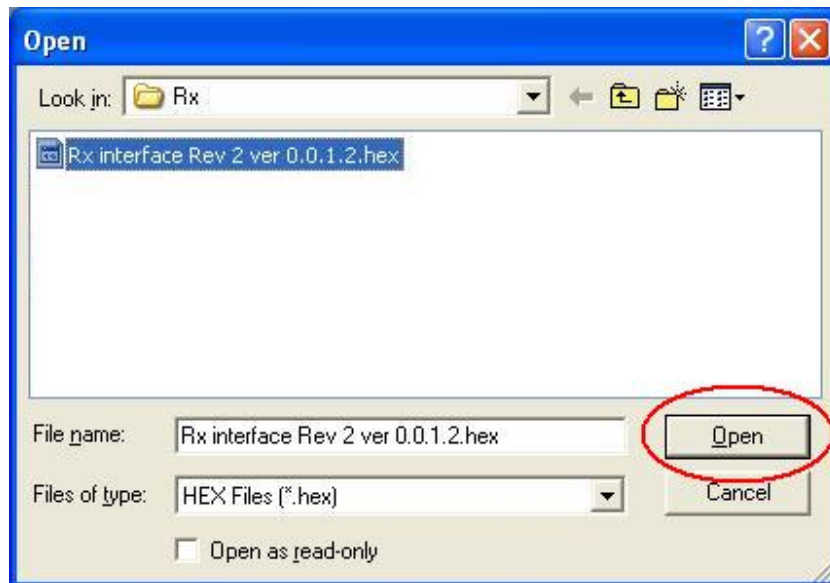

11. At the end of the transfer, the following screen appears.

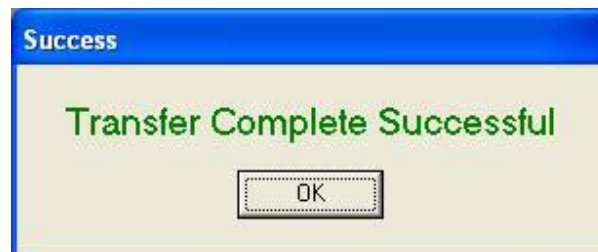

12. Click on the Ok button to close the window.

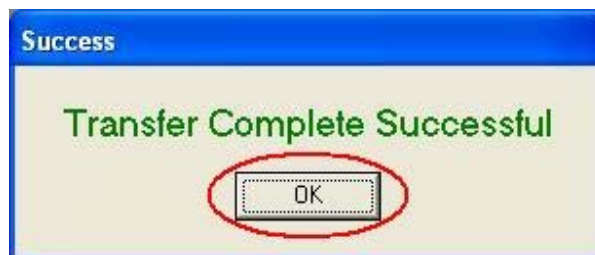

## 10 Technical help

If you encounter a problem not described in this manual, do not hesitate to contact **Instrumentation GDD Inc.** for help at:

Tel.: (418) 877-4249  
Fax: (418) 877-4054  
Toll free line: 1 877 977-4249  
e-mail: [gdd@gddinstrumentation.com](mailto:gdd@gddinstrumentation.com)

Emergency out of business hours:

Pierre Gaucher:	Home phone:	(418) 657-5870
	Cell phone:	(418) 261-5552
Régis Desbiens:	Home phone:	(418) 658-8539
	Cell phone:	(418) 570-3408

Any GDD IP Receiver that breaks down while under warranty or service will be replaced free of charge upon request for the duration of repairs, except for shipping charges. This service is subject to instrument availability but we have been able to honour this commitment up to now.